

EIS measurement after each multiple charging/discharging cycles

Purpose

This test is to demonstrate coin cell battery's charging/discharging cycle with EIS measurement. If you want measure eis after multiple charging/discharging cycles, you can use batch function to do it.

You can make technique file for CC/CV cycle test using CC/CV test or CC/CC test in technique menu and prepare EIS test technique file.

This demonstration's test condition is;

- ◆ Constant current charging: 20 mA
- ◆ Constant voltage charging: 4.2V
- ◆ Constant current discharging: 20mA
- ◆ EIS measurement per 3 charging/discharge cycles
- ◆ Total 30 cycle charging discharging and 10 times PEIS measurement
- ◆ EIS measurement at each capacity interval
 - Initial frequency: 1MHz
 - Final frequency: 0.1Hz
 - Amplitude: 5mV
 - Points per decade: 10

Preparation

- ZIVE SP/MP electrochemical workstation
- 4.2V Li ion Coin cell
- Coin Cell holder

Cell Connection

+ electrode(Green lead & Blue lead)

- electrode(White lead & Red lead)



Procedure

1. Turn the Power switch on the ZIVE SP/MP electrochemical workstation
2. Open the SM software by clicking the SM icon. The following progress box will appear, and will show the progress of checking instrument configuration and communication between ZIVE SP/MP electrochemical workstation and PC.



If the link is successfully connected, Click “OK” button on the box then the progress box will automatically disappear and SM software will appear. If the link failed, The following progress box will display then click the “Retry” button.

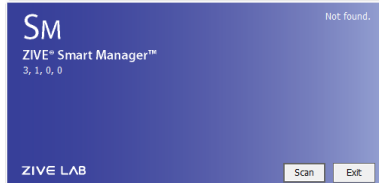

If the link failed again after clicking “Retry” button, you need to check USB cable connection.



3. CC/CV cycle test technique file: Click New technique function icon (or select Experiment-Techniques on Experiment menu)
Then you can see the following menu

The screenshot shows the 'Techniques - [Untitled]' dialog box with the 'Technique - CC/CV test' selected. The 'Parameters' tab is active, displaying a table of parameters and their values.

ITEM	VALUE	Option
First action	Charge	<input type="checkbox"/> Ch Dch
Charge		
-Const. charge	20m	Current
-Const. voltage(V)	4.2000e+0	
-Charging time(s)	1:40	<input type="checkbox"/> Enable
-Limit current(A)	15m	Current
-Limit capacity(Ah)	10.000e-3	<input type="checkbox"/> Enable
-Rest time(s)	10	<input checked="" type="checkbox"/> Enable
Discharge		
-Const. discharge	20.000e-3	Current
-Const. voltage(V)	2.7000e+0	
-Discharging time(s)	1:40	<input type="checkbox"/> Enable
-Limit current(A)	10.000e-3	Disable
-Limit capacity(Ah)	0.0000e+0	<input type="checkbox"/> Enable
-Rest time(s)	10	<input checked="" type="checkbox"/> Enable
Cycle	3	
Sampling		
-Time(s)	10	<input checked="" type="checkbox"/> Enable
-Delta voltage	5.0000e-3	<input checked="" type="checkbox"/> Enable
-Delta current	200.00e-6	<input checked="" type="checkbox"/> Enable
IR Measure	<input type="checkbox"/> On	
I Range(A)	1 A	<input checked="" type="checkbox"/> Auto

4. Click "Save" button to save the technique file which contains the above parameter and save it as "cccvtest1" file name.



5. PEIS technique file: Click New technique function icon (or select Experiment-Techniques on Experiment menu)
Then you can see the following menu

The screenshot shows the 'Techniques - [Untitled]' dialog box with the 'Technique - Potentiostatic EIS' selected. The 'Parameters' tab is active, displaying a table of parameters and their values.

ITEM	VALUE	Option
Initial delay	<input checked="" type="checkbox"/> Enable	
-Duration(s)	1:40	
-Stability(V/s)	1.0000e-3	
Bias potential(V)	0.0000e+0	Eoc
Amplitude(V)	5.0000e-3	
Initial freq.(Hz)	1.0000e+6	
Middle freq.(Hz)	1.0000e+6	
Final freq.(Hz)	100.00e-3	
Sweep type	Log	
Density	10	
Iteration	1	
Init. I Range(A)	1 A	<input checked="" type="checkbox"/> Auto
Speed	Normal	

6. Click "Save" button to save the technique file which contains the above parameter and save it as "peistest1" file name.

7. Select batch editor

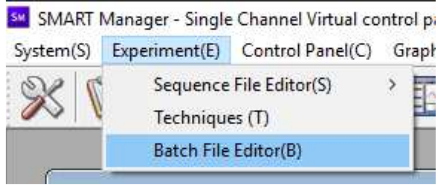

8. Click "Add" button and select "cccvtest1.ccv" and "peitest1.pei" file

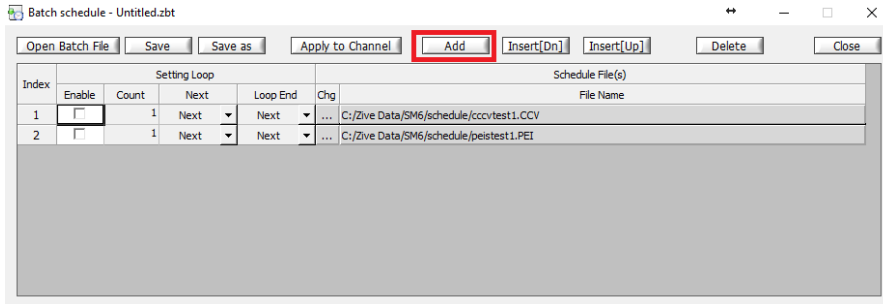

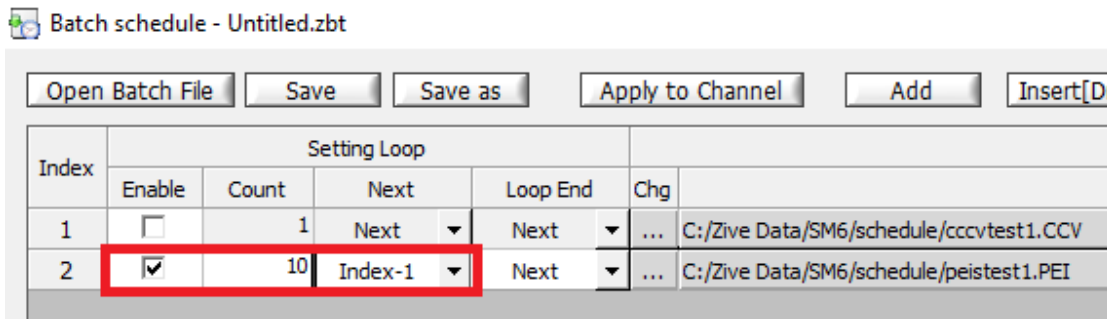

9. Click Enable for index2 to edit cycling of this batch process and input "10" for count. Select "index1" for next column.

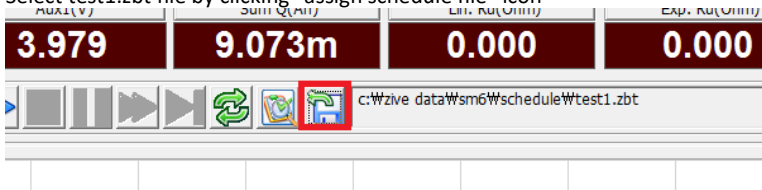

10. Click "Save" button to save this batch file using "test1" batch file name

11. Select test1.zbt file by clicking "assign schedule file" icon



To start experiment, click Start button 

12. After click start button, you can see the following box.

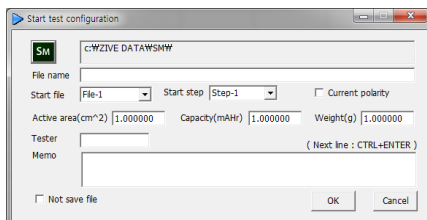

You can see real time plot as the following.

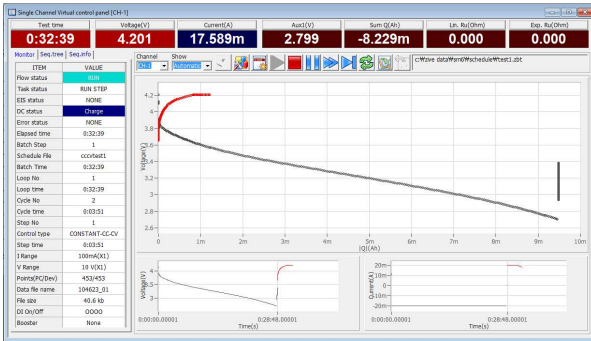

charge-discharge cycling

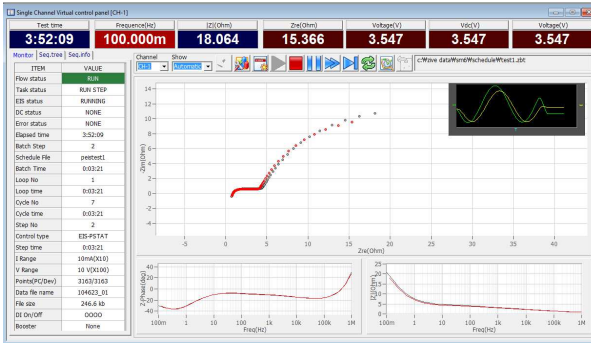

EIS measurement

13. You can display graphic or data editor by clicking right mouse on data file name

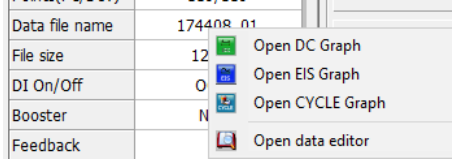

14. You can CC/CV charging-CC discharging profile when you select Open DC graph

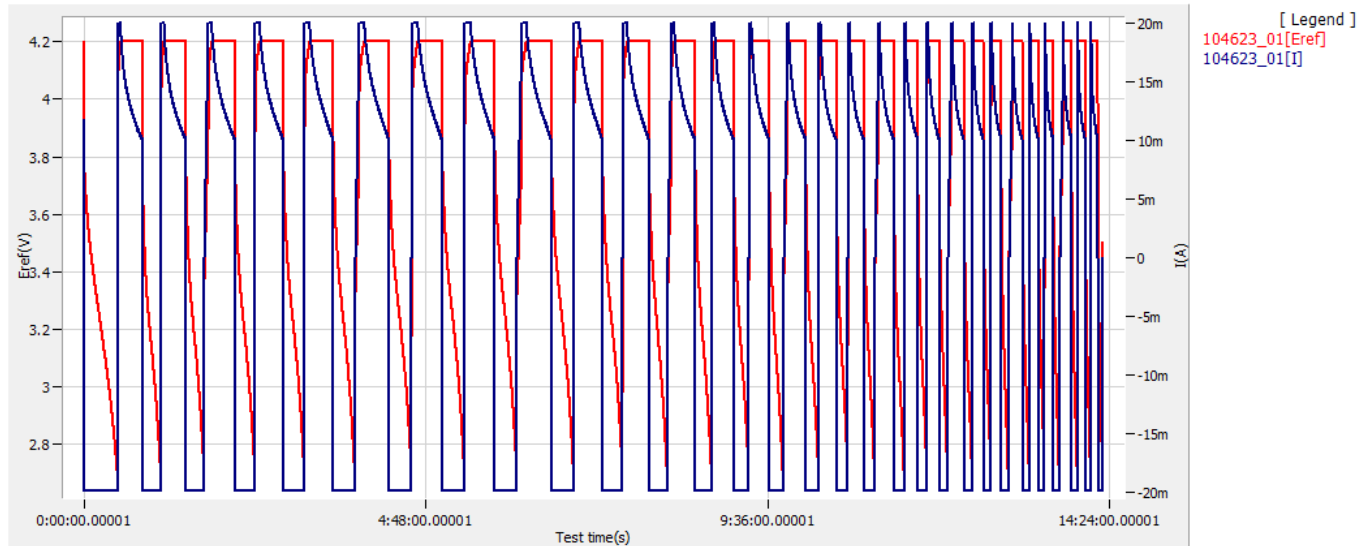

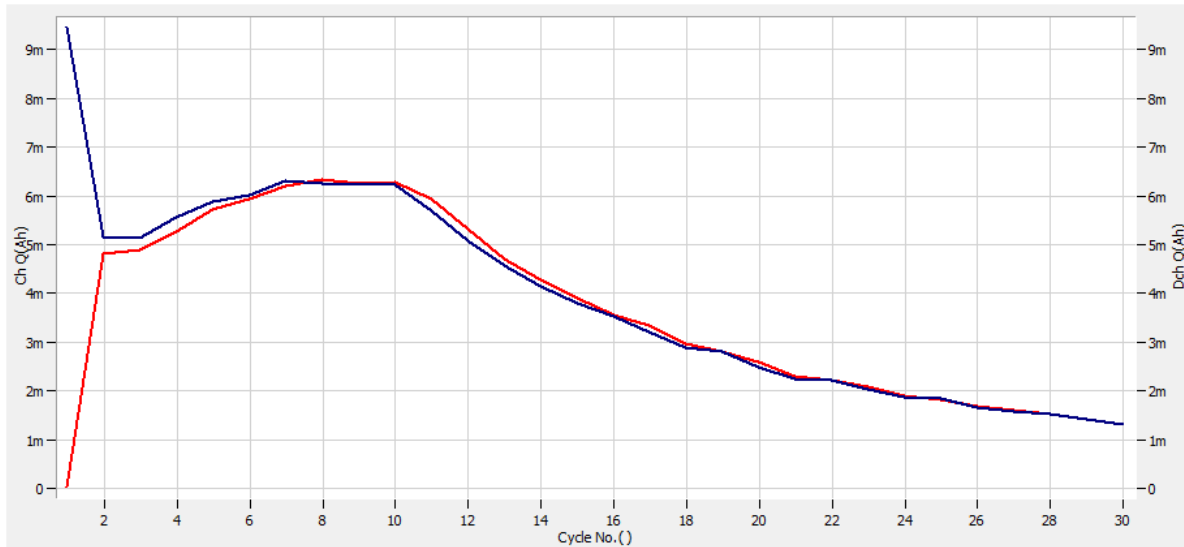

[Legend]
 104623_01[Ch Q]
 104623_01[Dch Q]



15. You can display graphic by clicking button on tool bar
 Click "Open data file" icon and select data file which you run the experiment.

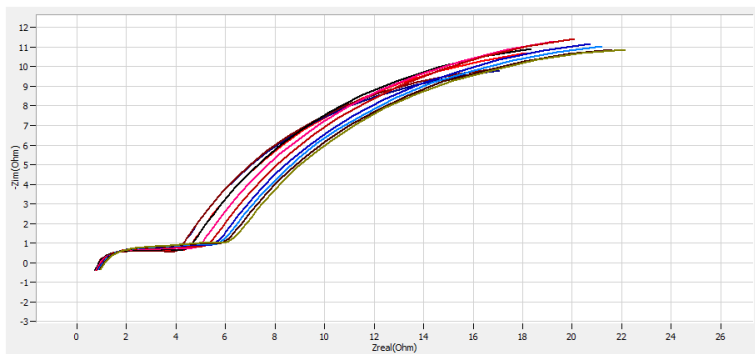

[Legend]
 104623_01[-Zim].2.4
 104623_01[-Zim].2.7
 104623_01[-Zim].2.10
 104623_01[-Zim].2.13
 104623_01[-Zim].2.16
 104623_01[-Zim].2.19
 104623_01[-Zim].2.22
 104623_01[-Zim].2.25
 104623_01[-Zim].2.28
 104623_01[-Zim].2.31



You can select Bode plot by clicking icon or Nyquist plot by clicking icon.

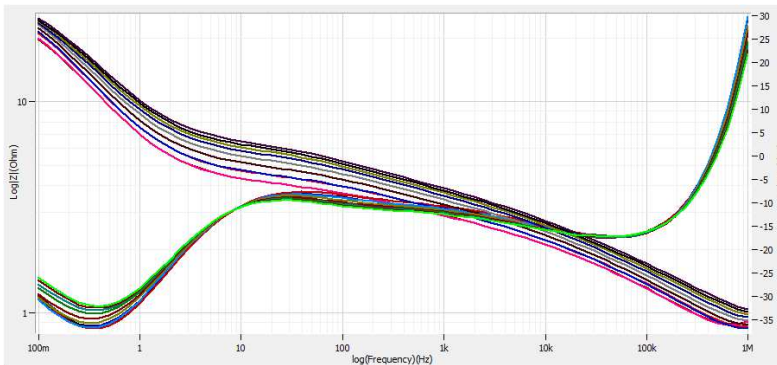

[Legend]
 104623_01[Log|Z|].2.4
 104623_01[Z-Phase].2.4
 104623_01[Log|Z|].2.7
 104623_01[Z-Phase].2.7
 104623_01[Log|Z|].2.10
 104623_01[Z-Phase].2.10
 104623_01[Log|Z|].2.13
 104623_01[Z-Phase].2.13
 104623_01[Log|Z|].2.16
 104623_01[Z-Phase].2.16
 104623_01[Log|Z|].2.19
 104623_01[Z-Phase].2.19
 104623_01[Log|Z|].2.22
 104623_01[Z-Phase].2.22
 104623_01[Log|Z|].2.25
 104623_01[Z-Phase].2.25
 104623_01[Log|Z|].2.28
 104623_01[Z-Phase].2.28
 104623_01[Log|Z|].2.31
 104623_01[Z-Phase].2.31



SM can split each EIS graph by selecting "cycle" in "division".

You can split data by file, cycle or step. Splitted data set's color was changed and graph line will be broken

ZMAN will split each EIS data automatically if you insert "cycle" mark..

Data Analysis

1. Open "ZMAN" by clicking ZMAN icon. ZMAN program is located c:\program files\zivlab\zman2.2 folder.

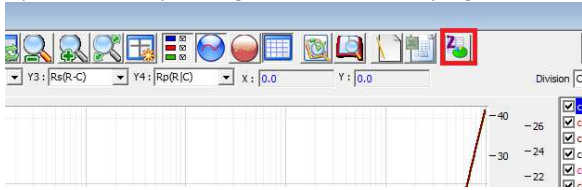

2. You can see the following window.

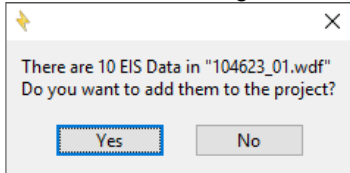

3. Click "Yes" then multiple EIS data will be splitted automatically.

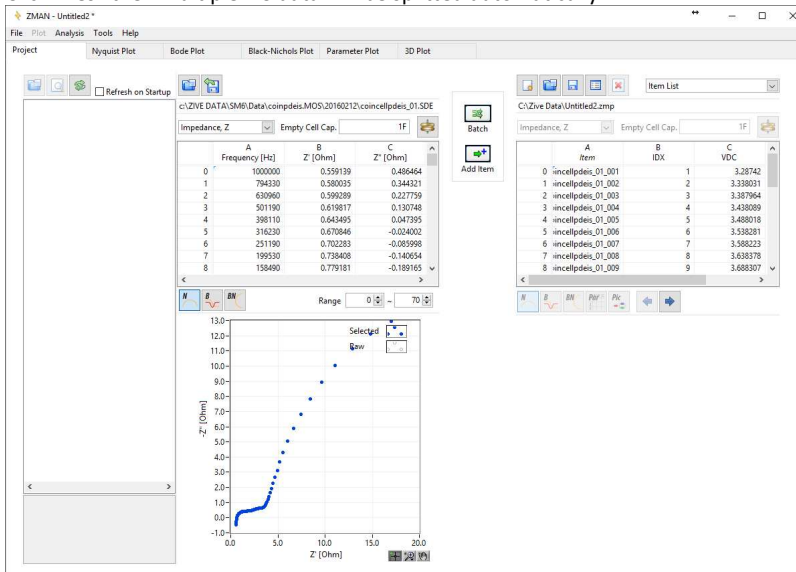

If you do not want to use all EIS data set, Click "No" then you can see select box.

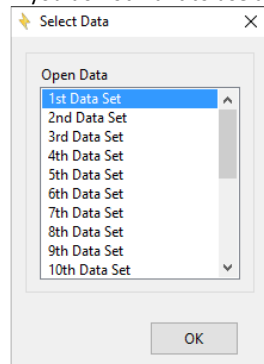

You can select one EIS data for analysis.

4. Parameter for voltage name can be changed .for example by clicking “edit item” button



Edit Items

Items	Control Parameters
0 charge_ipeis_coincell_01_001	First IDX
1 charge_ipeis_coincell_01_002	Second Battery Voltage
2 charge_ipeis_coincell_01_003	Third IDC
3 charge_ipeis_coincell_01_004	
4 charge_ipeis_coincell_01_005	
5 charge_ipeis_coincell_01_006	
6 charge_ipeis_coincell_01_007	
7 charge_ipeis_coincell_01_008	
8 charge_ipeis_coincell_01_009	
9 charge_ipeis_coincell_01_010	

Rename
charge_ipeis_coincell_01_001

OK Cancel

5. Change Idx to cycle No.

Edit Items

Items	Control Parameters
0 104623_01_001	First Cycle No
1 104623_01_002	Second VDC
2 104623_01_003	Third IDC
3 104623_01_004	
4 104623_01_005	
5 104623_01_006	
6 104623_01_007	
7 104623_01_008	
8 104623_01_009	
9 104623_01_010	

Rename
104623_01_001

OK Cancel

CHARGE DATA CONTROL SHEET

Impedance, Z Empty Cell Cap. 1F

	A Item	B IDC	C
0	eis_coincell_01_001		
1	eis_coincell_01_002		
2	eis_coincell_01_003		
3	eis_coincell_01_004		
4	eis_coincell_01_005		
5	eis_coincell_01_006		
6	eis_coincell_01_007		
7	eis_coincell_01_008		
8	eis_coincell_01_009		

Context menu: Copy, Paste, Copy Table, Export To Excel, Select All, Select Col, Select Row, Set Column Value...

Set Column Value

B(i) =

From To

Cols: A(i): Item
Functions: abs(x)

OK Cancel

Impedance, Z Empty Cell Cap. 1F

	A Item	B Cycle No.	C VDC
0	104623_01_001	3	3.591088
1	104623_01_002	6	3.554358
2	104623_01_003	9	3.540634
3	104623_01_004	12	3.582112
4	104623_01_005	15	3.61628
5	104623_01_006	18	3.641113
6	104623_01_007	21	3.663592
7	104623_01_008	24	3.674739
8	104623_01_009	27	3.685508

6. Click 2D nyquist plot

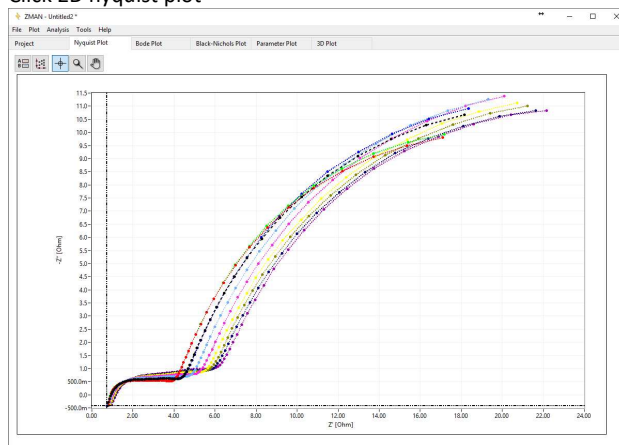

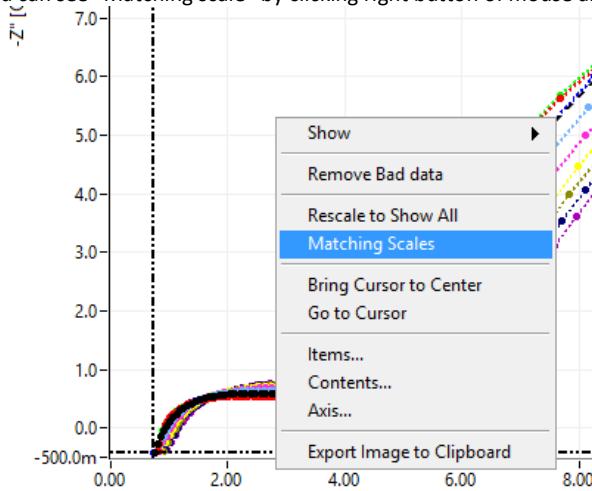

You can see "Matching scale" by clicking right button of mouse and select "Matching scale"

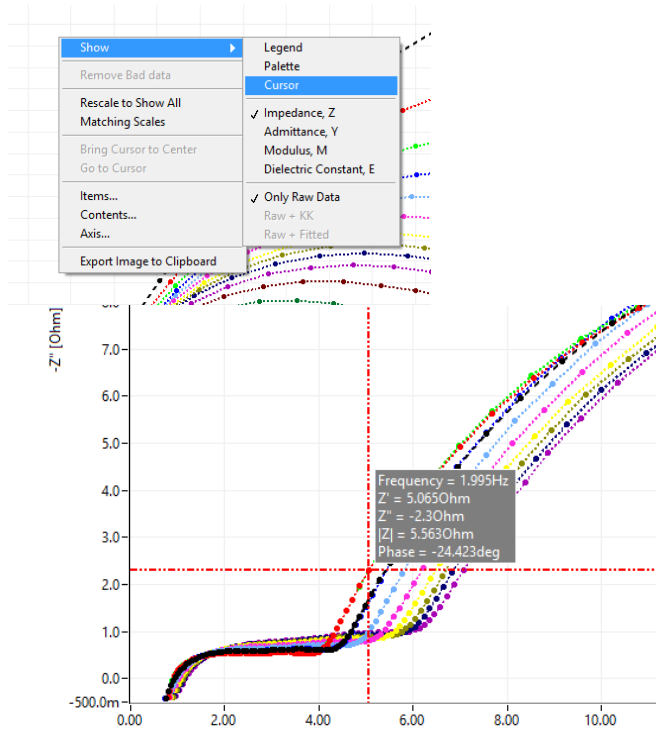

Matching scale is X axis scale and Y axis scale on Nyquist graph is same.

You can check each data value by selecting "cursor" with clicking right button of mouse .



You can move the point by dragging the mouse after check cursor icon .

7. Click 2D Bode

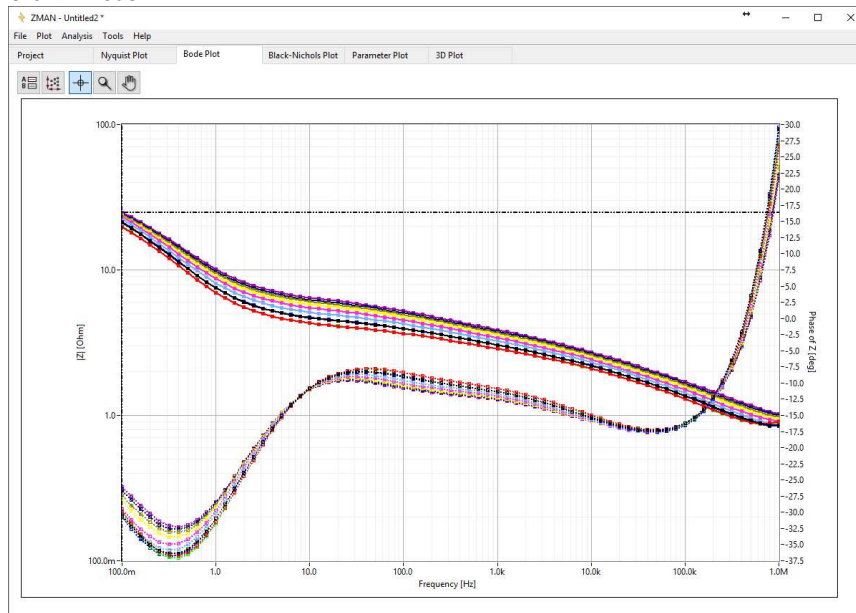

Analysis

a. Select data

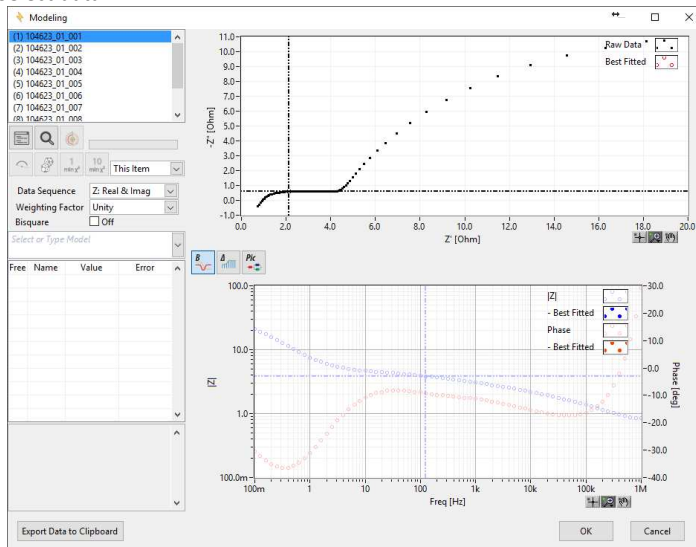

b. Search Model by clicking "search" button

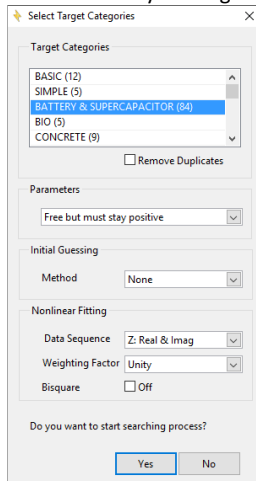

c. Select Battery library and None for Method.

d. Click Yes button

ZMAN software will try to find proper equivalent circuit automatically.

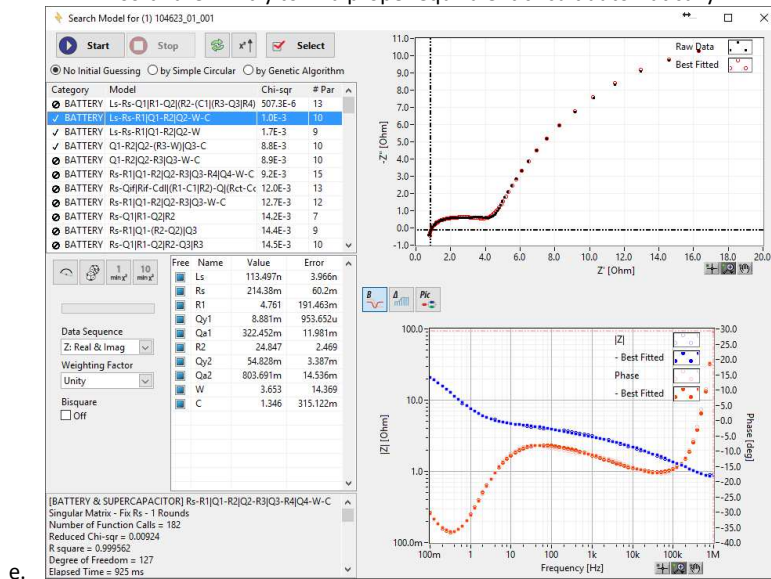

e.

f. Select the simplest model on upper row.

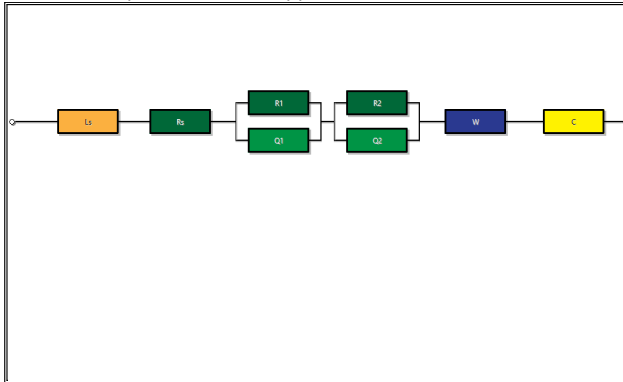

g. Click select button

h. Select sequential to fit other eis data set.

i. Click Minimize $\min x^2$ $\min x^2$ button, then ZMAN software will fit model automatically.

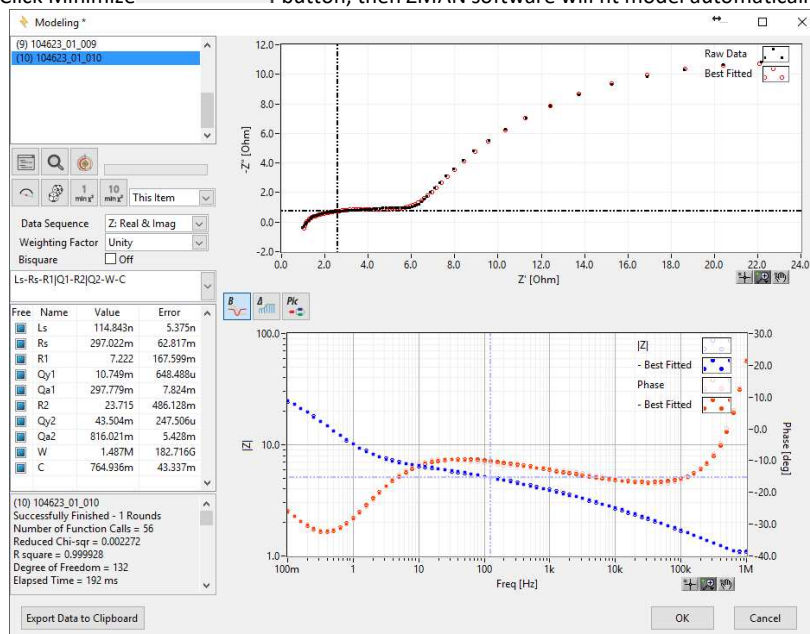

j. If you want overlay raw data and fitted data, Plot detail in Plot menu

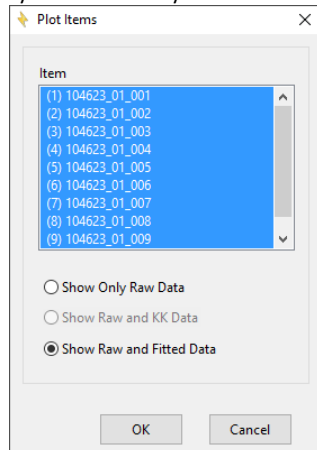

k. You can see Nyquist or Bode data with fitted data

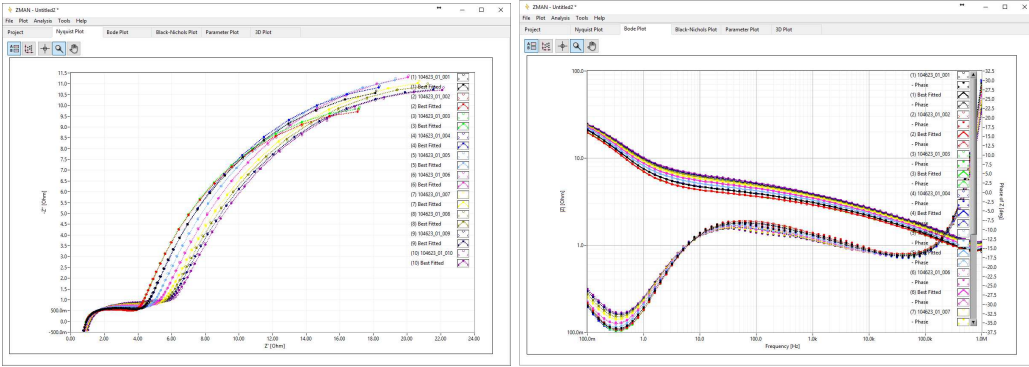

l. 3D graph vs. cycle number

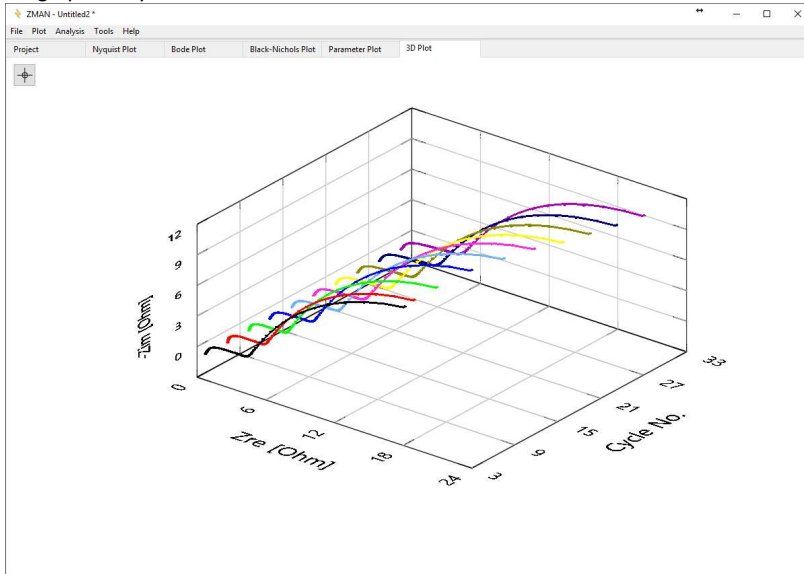

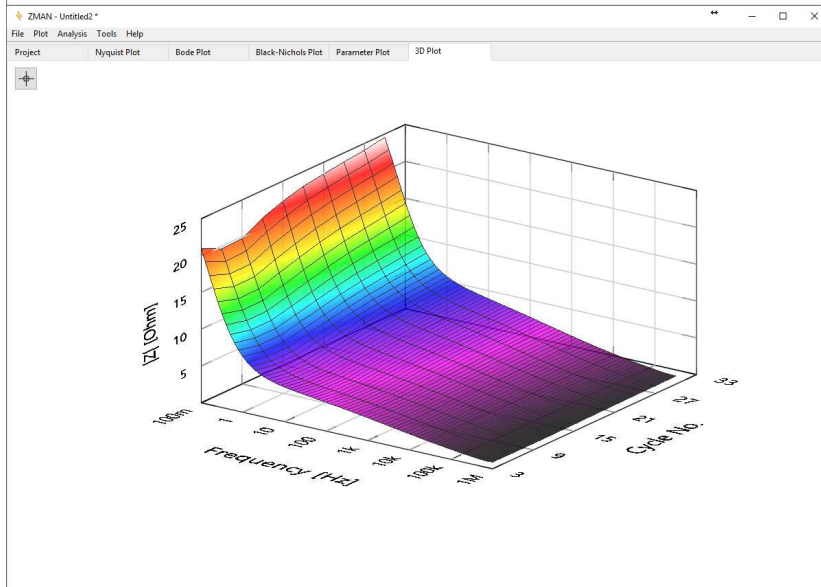
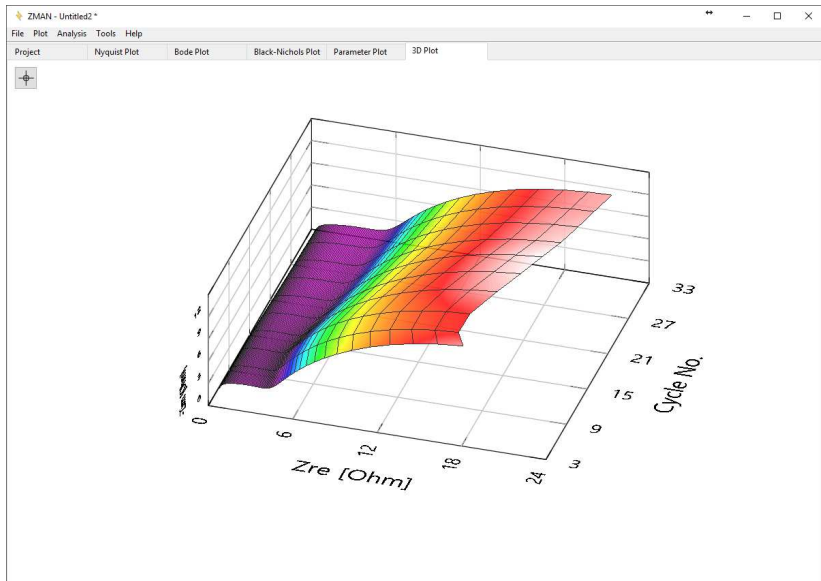

m. To view parameter plot, Select Plot-2D parameter

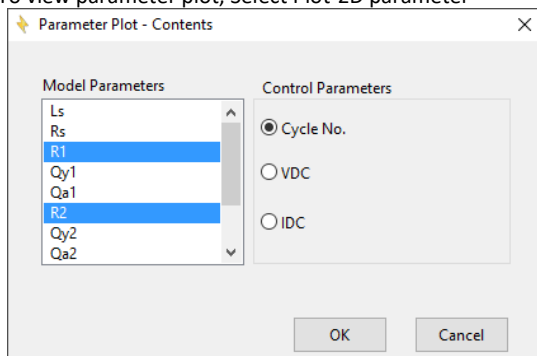

Select parameter(s) and click apply button

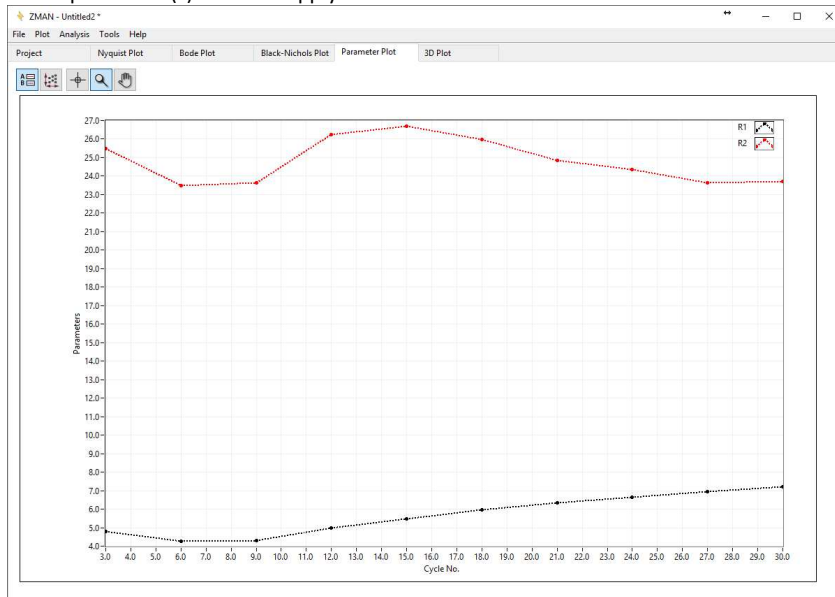

ZIVE LAB

Copyright© 2011 ZiveLab